

La pompa viene fornita con leva di azionamento L=600 mm  
The pump is supplied with acting lever 23.6 inch long

Codice ordinazione / Ordering code: **PM70**

<b>01</b>	Pompa a mano doppio pompaggio per cilindro a semplice effetto (Double pumping hand pump for single acting cylinder)	<b>PM70</b>
	Con soffietto (With rubber protection)	<b>P</b>
	Senza rubinetto di scarico con valvola di massima (Without unloading valve With relief valves)	<b>WRV</b>
	Senza rubinetto di scarico (Without unloading valve)	<b>W</b>
<b>02</b>	Optional	
	Con joystick (With joystick)	<b>J</b>
	Con leva di scarico Ø 27 mm (With unloading lever Ø 1.06 inch)	<b>L</b>
	Con rubinetto di scarico e valvola di massima (With unloading and relief valves)	<b>RRV</b>

### Schema idraulico - Hydraulic circuit

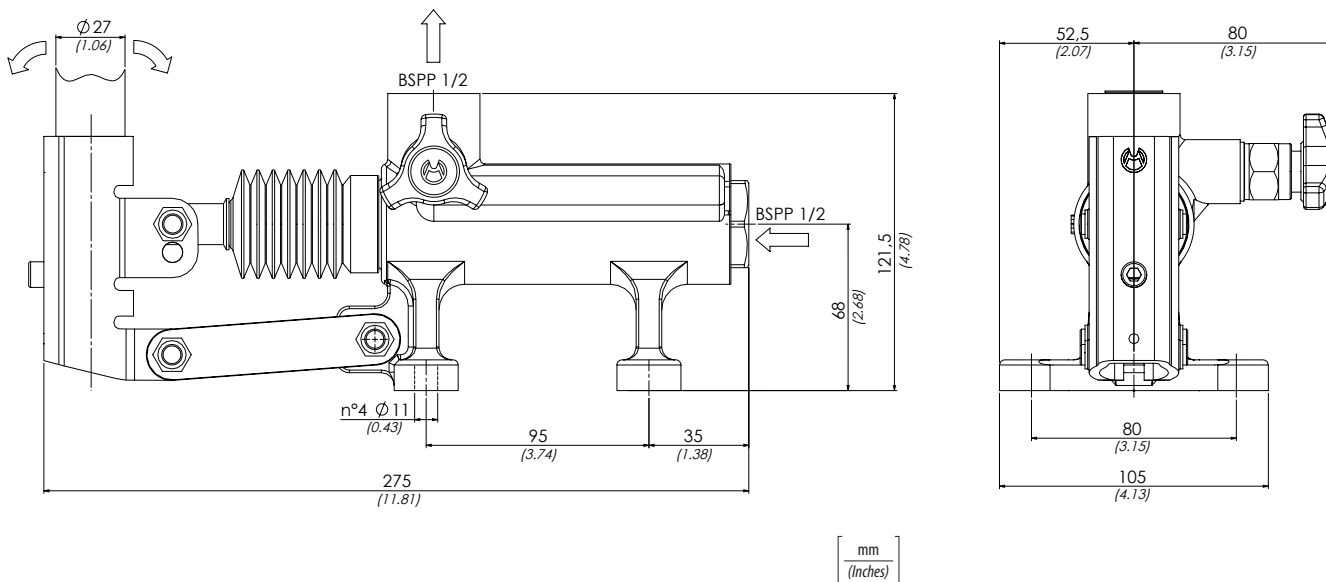
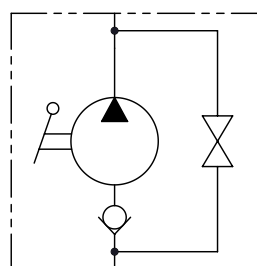

### Dati tecnici - Technical data

Olio idraulico/Mineral oil	ISO 6743/4 (DIN 51524)	
Viscosità olio/Oil viscosity	15-250 mm <sup>2</sup> /s (15 to 250 cSt)	
Classe di contaminazione max con filtro Max contamination index with filter	ISO 4406:1999 Classe 19/17/14	
Temperatura dell'olio/Oil temperature	-20°C +80°C	-4°F + 176°F
Temperatura ambiente/Ambient temperature	-20°C +50°C	-4°F + 122°F
È indispensabile l'utilizzo di un filtro per proteggere la valvola (filtrazione consigliata 15 µm) It is necessary a filter use to protect the valve (advised filtration 15 µm)		

### Caratteristiche tecniche - Technical characteristics

Tipo / Type	Cilindrata (cm <sup>3</sup> ) / Displacement (in <sup>3</sup> )	Pressione ottimale (bar) / Optimal pressure (PSI)	Pressione max (bar) / Max pressure (PSI)	Peso approssimativo (kg) / Approx weight (lb)
<b>PM70</b>	<b>70</b> (4.27)	<b>50</b> (725)	<b>200</b> (2900)	<b>5,6</b> (12.34)

### WRV

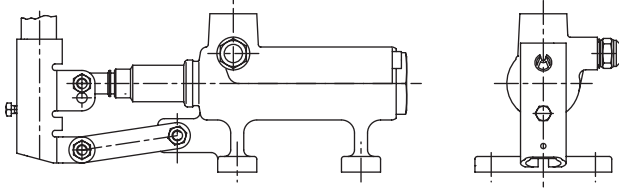

Valvola di massima  
(Relief valve)

Molla 40/350 bar  
Spring 580/5075 PSI

Taratura Standard 100 bar  
(Standard Setting) 1450 PSI

### L

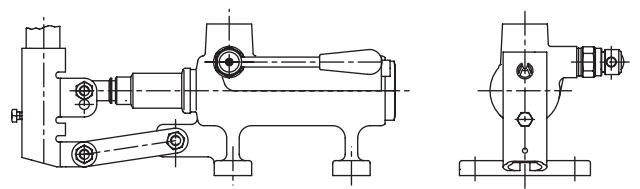

### W

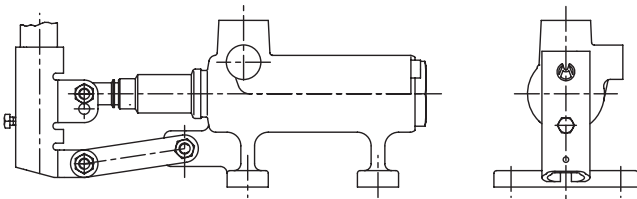

### J

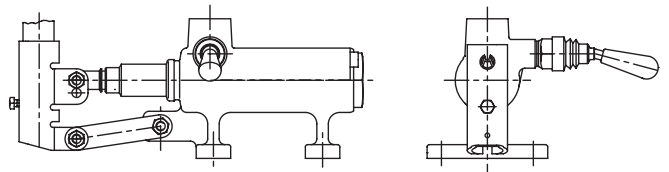

### RRV

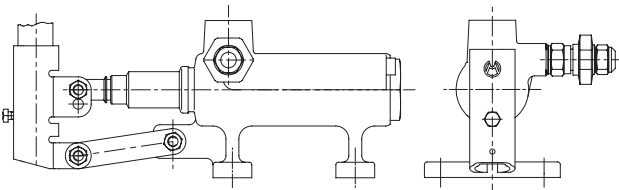

**Sforzo esercitato all'estremità della leva - Effort operating at the end of the lever**

